

F1 TERM 1 ASSIGNMENT

ALL SUBJECTS

SET 2

Attempt this assignment & Present on Opening Day

For Set 3 Assignment & Marking Schemes/Answers Call/ Whatsapp 0705525657

NAME: ADM NO:

SCHOOL: CANDIDATE'S SIGN:

GEOGRAPHY

1. What is environment? (2marks)

2. Name three human features (3marks)

3. Name two Greek words from which term geography originate (2marks)

4. If the local time in Nairobi on longitude 37° E is 10PM .what will be the time at Buchanan Liberia on longitude 10° W(4marks)

5. a)What is an eclipse (2marks)

b)Differentiate between solar and lunar eclipse(2marks)

FOR MORE E-RESOURCES CALL: 0705525657/0770195807

6. Give three reasons as to why the interior of the earth is hot (3marks)

7. a) Give two dates in a year during which the number of hours of darkness is equal in both the north and south poles (2marks)

b) State four factors that support life on planet earth (4marks)

8 a) State three factors that influence weather (3marks)

b)The table below shown below represent rainfall and temperature of station

X. Use it answer the following questions

Months	J	F	M	A	M	J	J	A	S	O	N	D
Temp in c	30	31	31	31	30	29	28	28	29	29	29	30
Rainfall in mm	250	250	325	300	213	25	25	25	100	275	380	200

a)Calculate the mean annual range of temperature (2marks)

- i. Calculate the mean annual rainfall for station X(2marks)
- ii. With an aid of a well labeled diagram describe how relief rainfall is formed (6marks)

9.a)Write down two types of questionnaires (2marks)

b)What factors must be considered in selecting methods of data collection (3marks)

c) State four advantages of using questionnaires in collecting of statistical data (4 marks)

d) i) Study the table below of a station B in a month of July and answer the following questions

Direction of the wind	N	NE	E	SE	S	SW	W	NW	CALM	TOTALS
No of days	3	3	1	1	2	7	6	4	4	31

ii) Use the suitable technique to present the data (6 marks)

d) State three disadvantages of using a wind rose to represent data (3 marks)

e) Name four methods of recording statistical data (4 marks)

) What is a map (2 marks)

b) List down four types of maps (4 marks)

c) Outline five uses of maps (5 marks)

11.a) List down three methods used in analysing statistical data (3 marks)

b) If the study of a farm, 10 hectares are found to be devoted to coffee growing and the total acreage is 100 hectares, what is the percentage of the area under coffee (1 mark)

c) A pupil was requested to pick out fourteen numbers randomly from a set of numbers. She picked 20,1,66,42,12,6,15,12,42,100,3,82,42,37

calculate

- i. The mean of data (2marks)
- ii. The mode of data (2marks)
- iii. The median of the data (2marks)

SET 2 FORM 1 HOLIDAY ASSIGNMENT

HISTORY

INSTRUCTIONS TO THE CANDIDATE

- **This paper contains three Sections : Section A , B and C**
- **Answer all questions in Section A**
- **Answer all questions in Section B**
- **Answer two questions in Section C**

SECTION A

1. State the two theories explaining the origin of Agriculture. (2 marks)
2. Which was the first animal to be domesticated by man? (1mark)
3. Give two functions of Fort Jesus. (2 marks)
4. Define the term Mesopotamia. (1 mark)
5. List down any irrigation methods used in Egypt. (2 marks)
6. What does the term Agrarian revolution mean? (1 mark)
7. Define the term Third world Country. (1 mark)
8. Who were the early inhabitants of Kenya? (2 marks)
9. Name any two communities that belong to the coastal Bantus. (2 marks)
10. List down two items of trade from East Africa during the Indian Ocean trade. (2 marks)
11. Identify any two cultural aspects of the Khoisan stock. (2 marks)
12. What type of government does Kenya practice ? Give a reason.(2 marks)

SECTION B

- 13 a) Highlight five Mijikenda clans.(5 marks)

b) Explain five reasons for Nilotes migration from their original homeland. (10 marks)

14. a) Name any five early visitors to the East African Coast up to 1500AD. (5 marks)

b) Explain five reasons why the Portuguese succeeded in conquering The East African Coast.

SECTION C

15 a) State any five sources of information about East African coast up to the 19th Century.

b) Explain five reasons for the growth of the Indian Ocean Trade. (10 marks)

16. a) List five functions of the council of elders during the pre-colonial period. (5 marks)

b) Describe the social organization of the Agikuyu. (10 marks)

17. a) Name five Economic activities of the Maasai. (5 marks)

b) Explain five reasons for the coming of the Arabs. (10 marks)

SET 2 HOLIDAY ASSIGNMENT

FORM 1

CRE

Answer all the questions

1a) Identify six deuterocanonical books found in catholic Bible (7mks)

b) Give six uses of the bible in Christian life (6mks)

2a) Give the attributes of God from creation accounts (8mks)

b) What are the differences between first account and the second account of creation (5mks)

3a) Identify eight events that took place during the Passover night (8mks)

b) State the problems faced by Israel during exodus (6mks)

4a) Give the achievements of King David (6mks)

b) Outline six roles played by Prophet Samuel (6mks)

5a) Identify the commandments king Ahab and jezebel broke (5mks)

b) Give the reasons why Elijah faced danger and hostility in Israel (4mks)

6a) Outline the promises given to Abraham by God (7mks)

b) State the covenants in the modern life (5mks)

7a) Give the order of hierarchy of beings (7mks)

b) List down the specialist in Traditional African community (5mks)

8a) State the factors contributing to harmony and mutual responsibility in the African community (5mks)

b) What are the attributes of God according to African people (6mks?)

SET 2 FORM 1 HOLIDAY ASSIGNMENT

KISWAHILI

MAAGIZO: *Jibu maswali yote kwenye sehemu ulizopewa*

1. INSHA: (Alama 20)

Andika barua ya kuomba nafasi ya kujiunga na shule ya upili baada ya kupita mtihani wa darasa la nane

2. UFAHAMU

Soma taarifa ifuatayo halafu ujiu maswali

UMOJA NA UTANGAMANO WA KITAIFA

Taifa ni jamii ya watu wanaoishi pamoja na kuunganika kihistoria na kitamaduni chini ya serikali moja. Muunganiko huu hutokea kinasibu na watu kujikuta chini ya himaya moja. Umoja na utangamano katika taifa hutokana na mambo kadha wa kadha.

Kwanza kabisa ni ushirikiano baina ya wanajamii wenyewe. Umoja wao huletwa na lugha wanayotumia. Hapa nchini Kenya Kiswahili kimechangia pakubwa katika kuleta utangamano. Luhga ya Kiswahili inazungumzwa kote nchini.

Wananchi kutoka sehemu tofauti za nchi wanaweza kuwasiliana bila shida yoyote.

Pili, utawala wa serikali ya kitaifa huleta utangamano wa jamii katika nchi. Huduma za serikali hutolewa kwa wote bila ya ubaguzi. Nchi inapokuwa chini ya kiongozi aliyechaguliwa na wananchi hufanikisha umoja.

Jambo lingine ambalo huleta utangamano wa kitaifa, ni kuwoko kwa sera inayoongoza maazimio na malengo ya taifa. Viongozi na wananchi wote hujitahidi kuchangia katika kuyafikia maazimio na malengo ya taifa lao.

Utamaduni wa nchi nao ni muhimu katika kuleta umoja wa kitaifa. Mila, itikadi na kaida zenye manufaa na zinazokubalika na jamii hufanikisha kutambulisha taifa. Hivyo wananchi kupigania kwa jino na ukucha kuhifadhi utamaduni wao. Kwa mfano: sanaa za uigizaji na uimbaji nchini Kenya husaidia kutomelea umoja huu. Tamasha hizi ni chombo muhimu cha utangamano. Mfumo sawa wa elimu nchini ni njia nyingine ya kuimarisha umoja wa kitaifa.

Wafanyibiashara wanaposafiri kutoka sehemu moja ya nchi hadi nyingine hutangamana na wananchi wenzao wanapouza au kununua bidhaa na huduma. Utangamano huo hukuza umoja wao.

Maswali

a) Eleza maana ya taifa. (al 2)

b) Eleza umuhimu wa Kiswahili nchini Kenya. (al2)

c) Taja mambo manne ambayo huleta umoja wa kitaifa. (al4)

d) Eleza maana ya maneno yafuatayo kwa mujibu wa kifungu hiki. (al 2)

i) Utangamano.....

ii) Utamaduni

3. Matumizi ya lugha (al. 30)

a) Taja sifa mbili mbili za sauti zifuatazo. (al. 4)

i) /u/.....

ii) /e/.....

b) Yaja sauti mbili mbili ambazo ni, (al. 6)

i) Vipasuo.....

ii) Nazali.....

iii) Vikwamizo.....

c) Pambanua aina za maneno katika sentensi ifuatayo. (al. 2^{1/2}) Maharagwe yalivunwa na kutiwa ghalani.

- d) Panga maneno haya vizuri ili yaunde sentensi sahihi. (al. 2) Hodari Yule mwanamuziki nchi amezuru nyingi Afrika za.

.....
.....
.....

- e) Tunga sentensi moja moja kubainisha maana ya maneno yafuatayo; (al.2)
i) Paa

.....
..... ii) Shuka

.....
.....

- f) Kanusha sentensi ifuatayo; (al. 2)
Mwalimu anasahihisha kitabu cha mwanafunzi.

.....
.....

- g) Andika sentensi ifuatayo upya ukizigatia maagizo kwenye mambano. (al. 2) Mazingira yamehifadhiwa. (hali ya mazoea)

.....
.....

- h) Maneno yafuatayo hupatikana katika ngeli zipi? (al. 2)

1. Manukato.....

2. Sukari.....

- i) Tofautisha sentensi hizi. (al. 4)

1. Gari lilibwa

.....
.....

2. Gari liliibiwa

.....
.....

- j) Kamilisha sentensi zifuatazo kwa kutumia vitenzi vilivyo katakia mambano.(al. 2)
i) Sauti hii ilina fuudi wa kihindi. (shone) ii) Yuko wapi Yule
mgonjwa aliye..... hapa? (leta)

- k) Eleza maana ya msamiati ufuatao wa ushairi. (al. 2^{1/2})
i) Ubeti

ii) Mizani

.....
.....

iii) Mshororo

.....
.....

iv) Ukwapi

.....
.....

v) Dhamira

.....
.....

.....

4.ISIMUJAMII (al 10)

- a) Eleza maana ya;

i) Isimu

.....
.....
.....

iii) Jamii

.....
.....
.....

iv) Isimujamii

.....
.....
.....

v) Sajili

.....
.....
.....

vi) Lafudhi

.....
.....

5.FASIHI SIMULIZI. (al 10)

a) Eleza maana ya fasihi. (al. 2)

.....
.....
.....

b) Toa sifa nne ili kutofautisha fasihi andishi na fasihi simulizi. (al. 8)

.....
.....
.....

SET 2 F1 HOLIDAY ASSIGNMENT

MATHEMATICS

SECTION 50 MARKS

1. Add one thousand and fourty four to the product of one thousand and six and one hundred And eighty. (3 marks)
2. The GCD of two numbers is 17 and their LCM is 140. If one of the numbers is 20, find the other number. (3 marks)
3. Find the L.C.M of $X^2 + X$, $X^2 - 1$, $X^2 - X$. (3 marks)
4. Evaluate $-8 \div 2 + 12 \times 9 - 4 \times 6$ (3 marks)
 $56 \div 7 \times 2$
5. Evaluate $\frac{3}{8}$ of $\{7^{\frac{3}{5}} - \frac{1}{3}(1^{\frac{1}{4}} + 3^{\frac{1}{3}}) \times 2^{\frac{2}{5}}\}$ (3 marks)
6. Evaluate without using calculators or mathematical tables, leaving your answer as a simple fraction.
 $-4(-2) + (-12) \div (+3) + -20 + (+4) + (-6)$ (4 marks)
 $-9 - (15) \quad 46 - (8 + 2) - 3$
7. A number m is such that when it is divided by 30, 36, and 45 the remainder is always 7, find the smallest possible value of m. (3 marks)

8. Which of the following number is divisible by both 3 and 4? (3 marks) 120, 744, 306, 9564, 1504, 192, 86 and 36.

9. What must be added to the number below to make it divisible by 11, (3 marks)

82604 9

10. If $x = -2$, $y = -6$ and $z = 4$, find the value of $4xy$ (3 marks)

Z

11. Show the following operation on a number line (2 marks)

$(-7) + (-2) + (+6)$

Hence, evaluate the value of, $(-7) + (-2) + (+6)$ (1 mark)

12. Change the recurring decimal into fraction, 3.256 (3 marks)

13. By how much is the product of $\frac{9}{5}$ and $8\frac{1}{4}$ greater than 5? (3 marks)

14. Evaluate, $(\frac{5}{7} \times \frac{2}{3}) + (\frac{5}{6} - \frac{8}{9}) \div \frac{7}{15}$ of $\frac{5}{6}$ (3 marks)

15. The distance between two schools m and k is 2km. A market is situated between m and k one third of the distance from m and k. How far is the market from k? (3 marks)
16. A square room is covered by a number of whole rectangular slabs of sides 60cm and 42cm. Calculate the least possible area of the room in square metres. (4 marks)

SECTION B 50 MARKS

17. Kinyua spent $\frac{1}{4}$ of his net January salary on school fees. He spent $\frac{1}{4}$ of the remainder on electricity and water bills. He spent $\frac{1}{9}$ of what remained on transport. If he finally had sh.3,400, calculate

- a) His net January salary. (5 marks)
- b) Money spent on school fees. (1 mark)
- c) Money spent on transport. (2 marks)
- d) Money spent on electricity and water bills.

18. A minibus had 23 passengers at the beginning of a journey. Twelve passengers alighted at the first stop while 9 boarded six of those who boarded at the first stop alighted at the second stop and 12 got in. The minibus should not stop again up to the final destination. The charges from the starting point were sh. 50 up to the first stop, sh. 70 up to the second stop and sh. 85 up to the final destination.

- a) How many passengers alighted at the final destination? (3 marks)
- b) How many passengers were ferried by the minibus through the journey? (3 marks)

c) How much money was collected during the trip? (4 marks)

19. Find all the possible values of the missing digit(s) represented by (*) (10 marks)

a) $2*6$, $8*71$, $8*919$ are divisible by 11.

b) $396*5$, $48675*$, $349**$ are divisible by 9.

c) $3*7$, $1*43$, $81*60$ are divisible by 3.

d) $93*$, $85*2$, $90*4$ are divisible by 4.

20. Mr. Kamau wishes to buy some items for his son and daughter. The son's item costs sh. 324 while the daughter item costs sh. 220 each. Mr. Kamau would like to give each of them equal amount of money.

a) What is the least amount of money that he can send to each of them so that the money is fully utilized for items without remainder. (5 marks)

b) How many items will each person buys. (5 marks)

21. In 2010, Musa got 750 bags of coffee from his shamba. In 2011 his yield dropped by 30% due to drought and in 2012 his yield rose by 15% over that of 2011. A bag of coffee weighs 55kg and Musa was paid sh. 7900 per tone in 2010. Thereafter the price per tone increased each year by 10%. Find his earning from coffee for each of the three years. Hence, find his total income from coffee for three years. (10 marks)

22. a) The Highest Common Factor(HCF) of 182 and x is 26 and the L.C.M of 182 and x is 1092. Determine the value of x. (3 marks)

a) Muigai had sh. P; Nzau had four times as much as Muigai. Muli had half as much as Nzau.

i) Write an expression that gives the total amount of money the three people had. (1 mark)

ii) If $p = \text{sh. } 1500$, how much money did they have altogether? (3 marks)

b) 

w

x

Find the values of x, y, w, and z giving reason. (4 marks)

23. Five companies employed 2340, 3455, 675, 960 and 1350 workers. The first company laid off 1 worker for every 5 workers, while the other three recruited 2 new workers for every 3.

a) What was the total number of workers at the beginning? (2 marks)

b) How many people:

i) Lost job (3 marks)

ii) Got job (3 marks)

c) What was the total number of workers finally? (2 marks)

24. a) The masses in kilograms of 20 bags of maize were; 90, 94, 96, 98, 99, 102, 105, 91, 102, 99, 105, 94, 99, 90, 94, 99, 98, 96, 102, and 105.

i. State the mode. (1mk)

ii. Calculate the mean mass per bag (4 marks)

b) A fruit vendor bought 1948 oranges on a Thursday and sold 750 of them on the same day. On Friday, he sold 240 more oranges than on Thursday. On Saturday, he bought 560 more oranges. Later the day, he sold all the oranges he had at a price of Ksh. 8 each. Calculate the amount of money the vendor obtained from the sales of Saturday. (5 marks)

SET 2 HOLIDAY ASSIGNMENT

ENGLISH

TIME: 2½ hrs

INSTRUCTIONS TO CANDIDATES

1. FUNCTIONAL WRITING

Weather conditions in your present school is not favourable for you. You feel sick all the time and this has affected your performance. Write a letter requesting for admission in another school.

Explain your condition, and why you would like to transfer to that new school. (10mks)

2. Read the passage below and then answer questions that follow.

A new system modeled on Continuous Assessment Tests [CATs] will soon replace ranking of teachers, learners, schools and regions in both KCPE and KCSE according to the Cabinet Secretary for Education Science and Technology.

In the meantime, the ministry has constituted a team of experts to work out on an elaborate, credible and all-inclusive standard system that the management of schools would use in conducting the tests from the moment learners join school to the time they complete studies. This will include collaboration with the Education Ministry, the Examinations Council, Parents Association and Teachers Unions.

According to the Ministry's plan, the accumulated marks awarded over a period of time in all areas of learning, including co-curriculum activities would count towards the final results when one leaves school either after KCPE or KCSE examinations. To achieve the best possible grading and desired results, those charged with implementing the new program would have to consider all the important aspects of administering CATs at various levels of learning and teaching. The new system which would be implemented any time soon will serve as an alternative after the recent banning of ranking on performance of schools and candidates in national examinations, though there have been calls from a section of parents, Kenya National Union of Teachers and The private Schools Association to have the Minister rescind his decision on ranking.

It is worth noting that in the CATs program, learners are examined continuously during their education and results considered after leaving school. It is an evaluation conducted over time; in other words, you are examined right through your learning process and not after the learning process [summative evaluation]. By doing this assessment, you can track the improvement of the learner; you will be able to give more support and guidance and the learner will have more opportunities to improve.

It has also been established that CATs can provide early indicators of likely performance of learners, something that can be of great help to the students themselves. It can also provide details of what has been learned at a particular stage of the course.

The CS said that after working out the new grading system for KCSE and KCPE candidates to be used by schools, the system would become a policy where KNEC will be left with no other choice but to make it operational to end the public outcry on scrapping ranking of schools teachers, candidates and regions. However, we are waiting to see if the teachers, some of whom have been accused of perpetuating examinations' vices, will uphold the integrity that is in doubt.

[Adapted from Education News:Jan 10-22, 2015]

(a) State what are normally ranked after KCPE and KCSE have been announced. (2 marks)

.....
.....
.....

(b) List four groups that will collaborate in all-inclusive standard system before its inception.(4marks)

.....
.....
.....

(c) In note form, state four advantages of the new system. (4 marks)

.....
.....
.....
.....

(d) Prove that the banning of ranking is not approved by all. (2 marks)

.....
.....

(e) Which groups are not happy with the banning of ranking? (3marks)

.....
.....

(f) Write a word from the passage that has the same meaning as: (4marks)

- i. Partnership
- ii. Evils
- iii. Evils
- iv. Honesty

3. Read the poem below and then answer questions that follow.

Your love flows through my veins
 like the Nile River flows through the
 sands of Eygpt.
 Love flows through my veins like rivers that
 break off into endless streams and water the
 gardens of the green stems of torn covered rose
 bushes.

In my veins, you flow, as a sparrow flies
through the blue skies in beauty.
You are the blood that flows through my veins
and later settles deep in my heart and embraces
me with a hug of intimacy.

Love flows through my veins like endless notes played by
the sweetest composer along with his private orchestra
playing a lovely melody. Rivers, streams break off and flow
into lakes and oceans, Like my veins that lead to my heart,
you are always there flowing through my veins.
Your love flows through my veins.

(a) Who is the speaker in this poem? (2marks)
.....
.....

(b) Describe what the poem above is about. (4marks)
.....
.....
.....

(c) Identify **three** instances of similes in the poem. (3marks)
.....
.....
.....

(d) Give this poem a suitable title. (1mark)
.....

4. CLOZE TEST

Read the passage below and then fill in the blank spaces with the most suitable words. Use only ONE word in each space. (10marks)

We are often advised to be confident; confidence comes when we feel passionately about what we perform, what we have achieved, and what we can offer.

Lack of ...1.....can hinder a lot of things, ranging from how you get ahead in your career to the number of skills you are able to acquire. It is a determining factor in the way you direct
.....2..... career. Confidence is conveyed from inner to the3..... through
the words you speak and the posture you assume. Building confidence is ...4..... a one day affair.
Neither does it take other people to build your confidence.

...5.....remember an interview I once conducted for secretaries, and the memory of one woman is intact. She stammered from the point she entered the office ...6..... the moment she left. Thinking that it

was interview jitters, we called ...7.....again, based on her technical qualifications rather than her presentation. She presented ...8..... same problem. We settled on a different candidate because confidence was a key qualification ...9.....the job which involved dealing ...10..... clients and colleagues.

5) ORAL SKILLS

(a) Read the riddling convention below and then answer questions that follow. **Oguma:**

I have a riddle!

Tonny: Throw it.

Oguma:What is so fragile that when you say its name you break it?

Basil:Glass.

Tonny: Plate.

Oguma: You both are wrong. Give me a city.

Tonny: We have given you Kisumu. **Oguma:**

The answer is silence.

i. Name the: (2marks)

I. Respondent

II. Challenger ii. Identify the following parts of the convention. (3marks)

I. Prize

II. Guess

III. Solution

(b) Fill in the more suitable word in the space provided. (5marks)

i. Eat that last greenin that plate. (been, bean) ii.

Are weto go to the church? (aloud, allowed) iii.

Push meon the swing. (higher, hire) iv. My skirt is too

big for my (waist, waste)

v. I did notthat you were coming. (know, no)

(c) Underline the silent letter in: (5marks)

i. Debtor ii. Asthma iii. Wren

iv. Catalogue v. Guess

(d) Considering the pronunciation of the underlined letter(s), write the odd word out. (5marks)

i. Flash, car, cat

ii. Birth, herd, guard

iii. Quack, cucumber, cent iv.

Much, choir, kick

v. Usual, genre, sure

5. GRAMMAR

(a) Rewrite the following sentences according to the instructions given. Do not change their meanings.

(4marks)

i. I go to church every week.

Replace the underlined words with one word.

..... ii.

Not all the times I travel to Mombasa.

Replace the words in bold with one word

.....

iii. I drank the porridge without sharing with anyone.

Replace the group of underlined words with a single word

..... iv.

I gave he a mango?

Correct the mistake

(b) Use the most appropriate form of the word in brackets to fill the blank space. (4marks)

i. He is myfriend. (child)

ii. The teacher expected all of us to demonstrate (kind) iii.

.....will make you successful in life. (honest) iv. What a provocative

.....that was! (laugh)

(c) Write the correct form of the adjective given in brackets. (4marks)

i. The artist's fingers werethan Juan's. (sensitive) ii. Vera

used thematerials she could. (good) iii. Musa ground the colours into the

.....powder. (fine) iv. Themoment came

when the principal asked Gifter to draw his

picture. (exciting)

(d) Without using the words underlined, rewrite the following as questions beginning with the words in brackets.

(4marks)

i. People handle old violins carefully. (how)

.....

ii. I saw him yesterday. (when)

.....

iii. Pianists sometimes play duets. (how often)

.....
iv. Some students play everywhere in the field. (where)
.....

(e) Fill in the most suitable preposition. (4marks)

i. The boy wentthe classroom. ii.

She is worriedher exams. iii.

Let me payTom.

iv. I have been expelledschool for my bad behavior.

b) Shovel

c) Pick axe

d) Garden line

e) Wheelbarrow

f) Sprayer

g) Ripsaw

h) Tape measure

i) Scraper

j) Marking gauge

8. a) State the reasons for preparing land before planting. (4mks)

b) What is a seedbed? (1mk)

9. Give reasons why the burning of Bushes as a methods of land cleaning should be discouraged. (2mks)

10. What is ridging? (1mk)

b) Give reasons why the following operations are carried out in crop production; i) Rolling. (1mk)

ii) Levelling. (1mk)

11. State the main sources of water on the farm. (3mks)

b) State the methods of water collection and storage in the farm. (3mks)

c) What are the four reasons for treating water for human consumption. (2mks)

12. a) What is;

i) Drainage. (1mk)

ii) Pollution. (1mk)

b) i) List six different types of drainage. (3mks)

ii) Describe the agricultural practices which lead to water pollution. (2mks)

13. a) Define the term soil fertility. (2mks)

b) State the characteristics of a fertile soil. (5mks)

14. a) What is the importance of organic matter in the soil? (5mks)

b) What are the functions of the following in the preparation of compost manure? (3mks) i) Topsoil

iii) Wood ash

iv) The layer of manure

15. Discuss the importance of livestock to a Kenyan farmer. (2½mks)

16. List the characteristics of a dairy cow. (2½mks)

17. a) Differentiate between the following breeds of livestock.

i) New Zealand white and Californian white. (2mks)

ii) Large white and landrace. (2mks)

18. What is the color of each of the following breeds of livestock?

a) Wessex saddle backs. (½ mk)

b) Toggenburg (½ mk)

SET 2 HOLIDAY ASSIGNMENT

BIOLOGY

Answer all the questions in the spaces provided.

1. Name the branch of biology involved in the study of
 - a. Relationships of living with each other and their environment.(1mrk)
 - b. Identification and classification of organisms.(1mrk)

2. The binomial name of housefly is MUSCA DOMESTICA.
 - i) Statetwo mistakes in the way the scientific name is written. (2mks)

 - ii) Re-write the name in correct manner following the rules of binomial nomenclature. (1mrk.)

3. State the use of each of the following apparatus: (3mrks)
 - I)Bait trap

 - ii) Specimen bottle

 - iii) Pitfall trap

4. Give the functions of thefollowing parts in a light microscope.(3mrks)
 - a. Diaphragm

 - b. Condenser

 - c. Objective lens

5. b) Why is it not likely to use an electron microscope in a school laboratory? 2mks

6. Study the diagram below and answer the questions that follow:

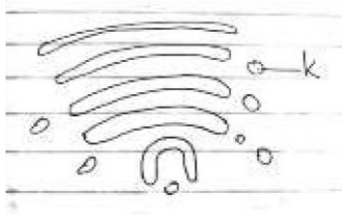

(a) Identify the organelle. 1mk

(b) Name the structure labelled K 1mk

(c) State two functions of the organelle named in (a) above. 2mks

7. (i) What is the importance of carrying out the following procedures when preparing temporary slides in the laboratory? (3mks).

(A). Adding water to the specimen.

(b). Staining the specimen.

(c). Using a sharp blade to make sections.

8. A student estimating a cell size of an onion epidermal cells observed the following on the microscope field of view using a transparent ruler.

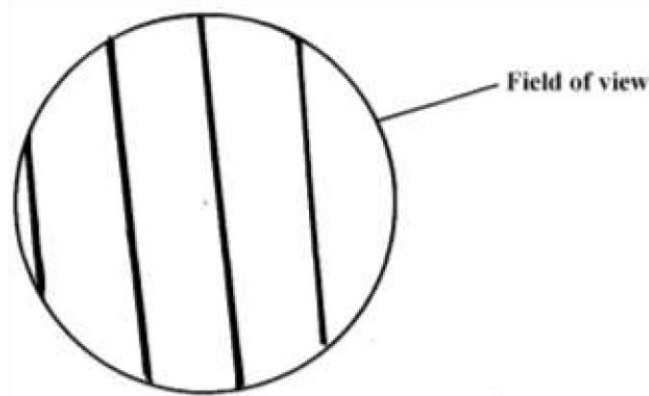

The student identified 20 cells across the field of view. Calculate the size of the cell in Micrometers (show your working) (3mks)

10. Define the term physiology(1mrk)

11. (a)Name the principal components of cell membrane (3mrks)

(b)(i) Why would a cell allow some substances to pass through it but not others? (1mrks)

(ii) Other than the property of semi- permeability stated in b (i) above, state two other properties of a cell membrane (2mrks)

(c)Explain what would happen to the red blood cells if placed in concentrated salt solution. 3mks

12. Define the following terms (6 marks)

- a. Isotonic solution

- b. Hypotonic solution

- c. Hypertonic solution

13. What is meant by the following biological terms?

(i) Crenation (2 marks)

ii) Haemolysis (2 marks)

14. What role does osmosis play in plants? (2 marks)

15. Distinguish between diffusion and active transport (2 marks)

16. Define the term nutrition (2 marks)

17. Name and explain the two types of nutrition (4 marks)

18. Differentiate between Chemotropism and Phototropism (4 marks)

19. Draw a well labelled diagram of a leaf showing the external features. (3 marks)

20. Define the term photosynthesis (2 marks)

21. What four conditions are needed for photosynthesis to occur?(4mrks)

22. (i)What is the importance of photosynthesis in nature?(2mrks)

(ii)The organelle below is important in the process of Nutrition.

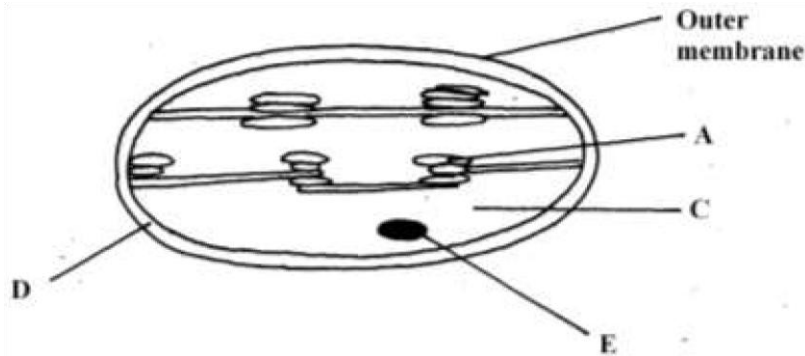

a) Identify the organelle. (1mk)

b) Name the part labeled (2mk)

A

C

23. Name the part where the following stages of photosynthesis occur(2mrks) Light independent stage

Dark stage

24. State the role of light in the processes of photosynthesis(1mrk)

25. Name the building blocks of ;(3mrks)

(I) Proteins

(ii) Carbohydrates

(iii) Fats

26. What are enzymes? (1mrks)

27. State the main properties of enzymes (2mrks)

SET 2 HOLIDAY ASSIGNMENT

BUSINESS STUDIES

1. Define the following terms as used in business studies. (8mks) a)

Good

.....

.....

..... b)

Services

.....

..... c)

Economics

.....

..... d)

Accounting

.....

.....

2. State **four** features of a good filing system. (4mks)

.....

.....

.....

.....

3. Outline **four** sources of business ideas. (4mks)

.....

.....

.....

.....

4. Give any **four** business activities. (4mks)

.....

.....

.....

5. Highlight **four** reasons why people engage in business activities. (4mks)

.....

.....

.....

6. Mention **four** types of resources that are important in business. (4mks)

.....

.....

.....

7. Fill in the blank spaces below (4mks)

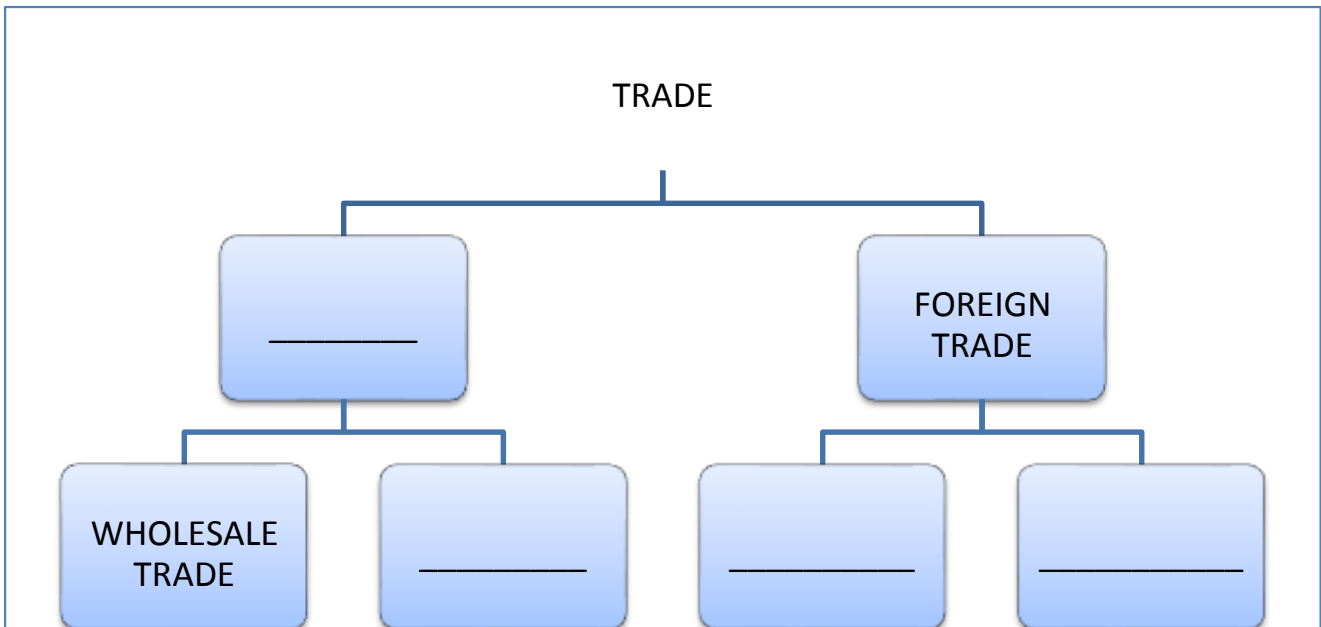

8. State **four** features of supermarket. (4mks)

.....
.....
.....
.....

9. Differentiate between goods and services. (5mks)

GOODS		SERVICES	
I		i	
Ii		ii	
Iii		iii	
Iv		iv	
V		v	

10. Mention any **four** small scale retailers without shops. (4mks)

.....
.....
.....
.....

11. Business studies are a wide subject that covers several disciplines. Outline those **five** disciplines.

(5mks)

.....
.....
.....
.....

12. Identify any **four** features of economic resources. (4mks)

.....

.....
.....
.....
13. State any **four** factors to consider when selecting office equipment. (4mks)

.....
.....
.....
14. Give **four** advantages of an open office layout. (4mks)

.....
.....
.....
15. Identify any **four** causes of a business success. (4mks)

.....
.....
.....
16. Differentiate the following terms as used in production. (6mks)

a) Free goods and economic goods.

.....
.....
b) Producer goods and consumer goods.

.....
.....
c) Public goods and private goods.

.....
.....
17. Mention **four** factors that hinder geographical mobility of labour. (4mks)

.....
.....
.....
.....

18. State **four** functions of an entrepreneur. (4mks)

SET 2 HOLIDAY ASSIGNMENT

CHEMISTRY

1. Explain why most laboratory apparatus are made of glass. (2mks)
2. (a) What is drug abuse? (1mk)

(b) Name three drugs that are commonly abused. (3mks)

(c) State two ways of preventing drug abuse. (2mks)

3. Study the diagram below and answer the question that follows.

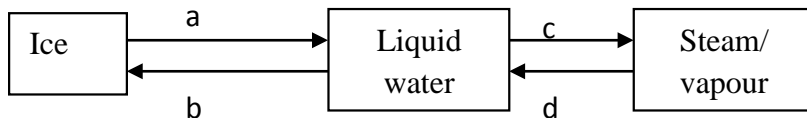

- a) Name the process labeled a, b, c and d. (2mks)
 - b) Draw a similar diagram to show the effect of temperature on solid carbon (IV) oxide (dry ice) (2mks)
4. Identify the elements present in the following compounds.
 - i) Magnesium oxide. (1mk)
 - ii) Zinc chloride. (1mk)
 - iii) Sodium sulphate. (1mk)
 - iv) Aluminium nitrate. (1mk)

5. State three differences between luminous and non luminous flame. (3mks)

6. The diagram below shows the effect of heat on hydrated copper (II) sulphate crystals.

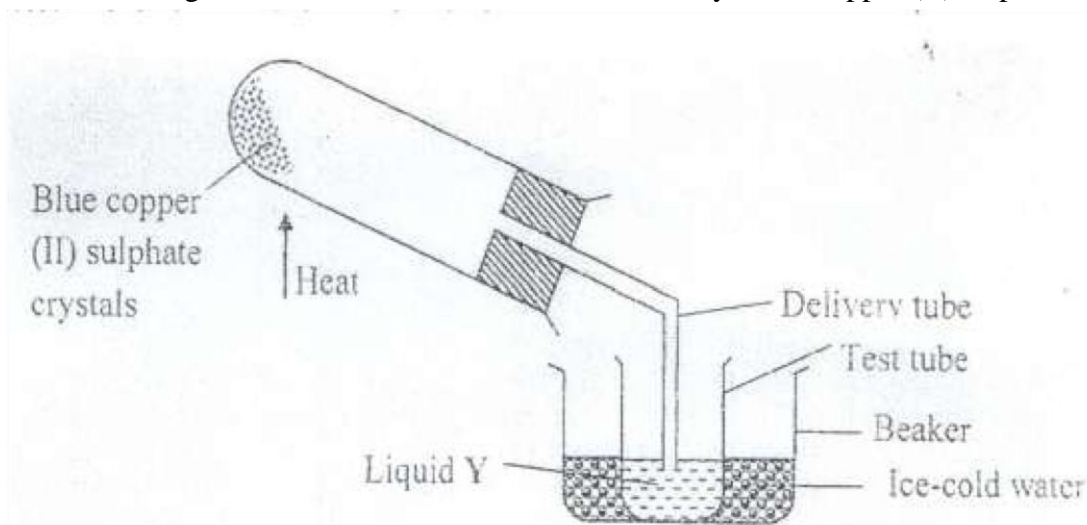

- State the colour of hydrated copper (II) sulphate crystals. (1mk)
- What observations are made inside the boiling tube after heating has taken place? (1mk)
- What is the use of ice-cold water in the beaker? (½ mk)
- Name liquid Y. (½ mk)
- What will be observed if the residue in the boiling tube is cooled and a few drops of liquid Y added to it? (1mk)
- What type of chemical change is exhibited by copper (II) sulphate? (1mk)

7. The graph below shows the shape of the curve obtained by a student when solid X

was heated to boiling.

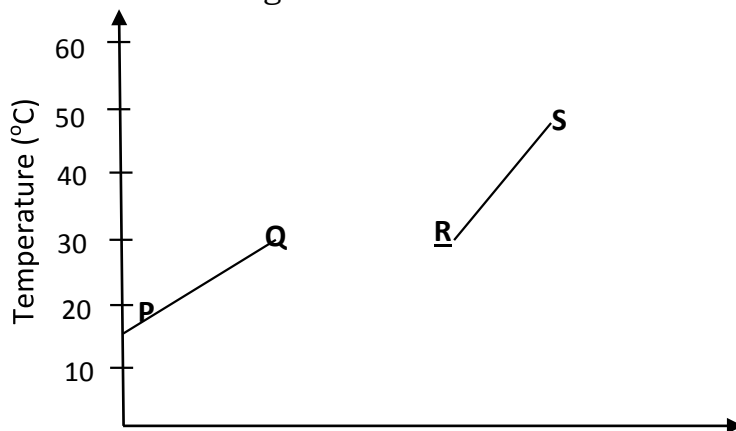

a) Determine the melting point of substance X. (1mk)

(b) After the experiment the student concluded that substance x was pure substance. Explain why he concluded so. (1mk)

(c) If candle wax was used in the above experiment the portion QR would be horizontal. What does this tell us about candle wax? (1mk)

8. (a) What is the effect of impurities on the melting and boiling point of substances? (2mks)

(b) Explain the following:

i) During extraction of metals from their molten compounds for example calcium chloride is added to rock salt during the extraction of sodium from sodium chloride. (1mk)

ii) In temperate counties there is spreading of common salt in the roads during winter. (1mk)

9. Distinguish between temporary physical and permanent chemical changes. (2mks)

10. (a) Write the names of the elements represented by symbols. (3mks)

i) K – ii) Cl –

iii) Fe – iv)

Mg –

v) C – vi) Be –

(b) Define:

i) Atom. (1mk)

ii) Compound. (1mk)

iii) Element. (1mk)

11. (a) Complete the following. (3mks)

i) Acid + metal → ii)

Acid + Base → iii) Acid +

Carbonate →

(b) Write word equations for the following reactions.

i) Zinc and hydrochloric acid. (1mk)

ii) Potassium hydroxide and sulphuric (VI) acid. (1mk)

iii) Magnesium carbonate and nitric (V) acid. (1mk)

12. Study the diagram below for the reaction between sodium carbonate and hydrochloric acid and answer the questions that follow.

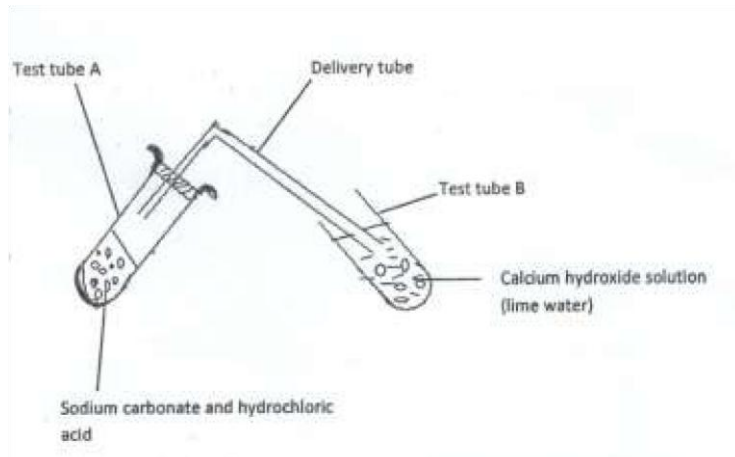

a) Explain what was observed in:

- i) Test tube A. (1mk)
- ii) Test tube B. (1mk)

(c) Write a word equation for the reaction which took place in test tube. (1mk)

13. State whether solutions with the following pH values are acidic, basic or neutral. (2mks) pH 3 – pH 11 – pH 14 – pH 7 –

14. Is air a mixture or a compound? Explain. (2mks)

15. The apparatus below were used to determine the volume of oxygen in air. About 200cm^3 of air were passed repeatedly from syringe A to syringe B over heated copper turnings as shown in the diagram.

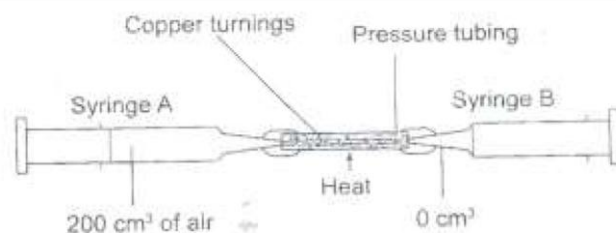

After sometime, the volume of air in the syringe A was 160cm^3 and syringe B, 0cm^3 a) Calculate the percentage of oxygen in the initial sample of air. (2mks)

(b) The percentage of oxygen calculated above was slightly less than the percentage of oxygen in air. Explain why. (1mk)

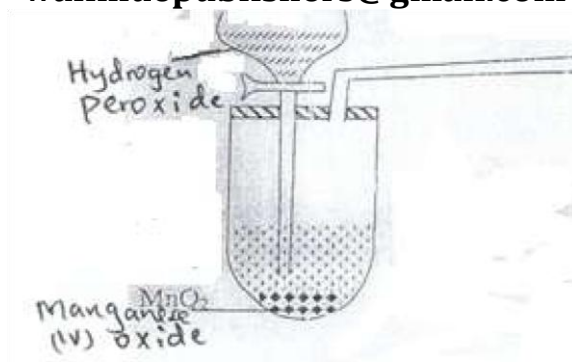

16. The set-up below was used to prepare a sample of oxygen gas. Study it and answer the questions that follow.



- a) Complete the diagram to show how oxygen can be collected. (2mks)
- b) Write a word equation for the reaction that produces oxygen above. (1mk)

c) State two physical properties of oxygen gas. (2mks)

d) State two uses of oxygen. (2mks)

17. Candle wax is an example of a hydrocarbon.

a) What is a hydrocarbon? (1mk)

b) Name the two products formed when hydrocarbons burn in oxygen. (1mk)

18. Study the figure below and use it to answer the following questions.

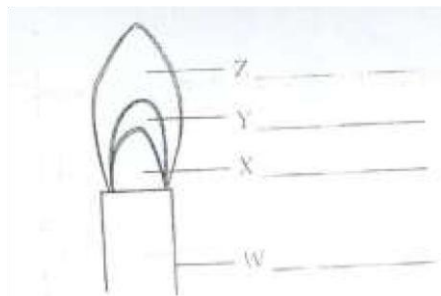

a) Name the parts labeled X and Y. (1mk)

b) Identify the flame. (1mk)

c) Which part of the flame is the hottest? (1mk)

19. The diagrams below show some physical methods of separating mixtures.

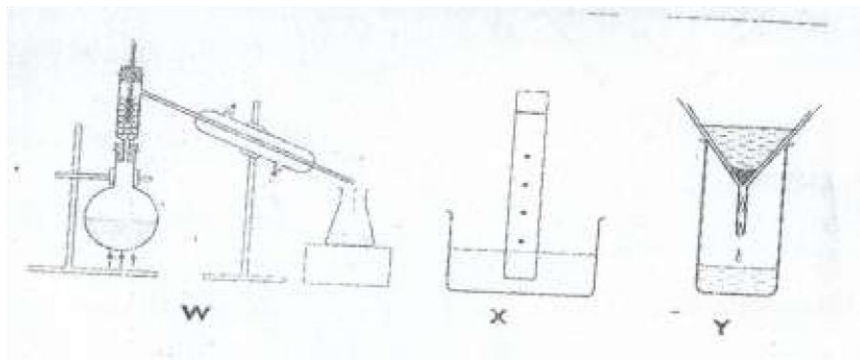

a) Name the methods of separation labeled W, X and Y.

SET 2 HOLIDAY ASSIGNMENT

PHYSICS

Attempt all the questions in the spaces provided.

1. Give two career opportunities in physics. (2 mks)

2. Give three basic laboratory rules. (3mks)

3. State with reason what will happen to the diagram if side A is broken with a needle, and draw the final diagram (4mks)

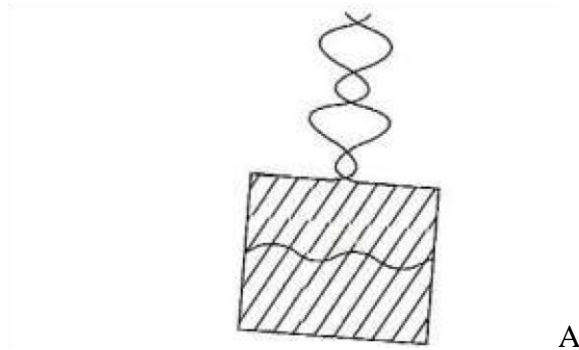

3. What is the first aid measure for the following accidents in the laboratory.

(i) Cuts. (3mks)

(ii) Burns. (3mks)

(iii) Electric shock (3mks)

4. Study the diagram below and indicate on the diagram the right position of the eye when taking the measurements. (3mks)

A

B

C

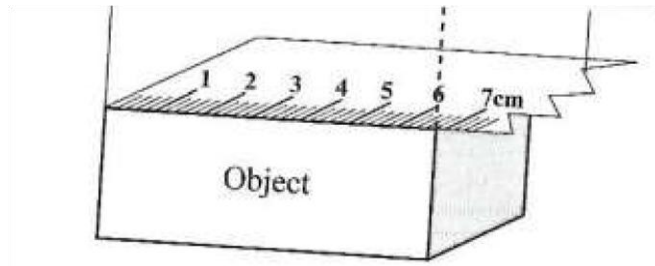

5. Estimate the height of the tree below.

(5mks)

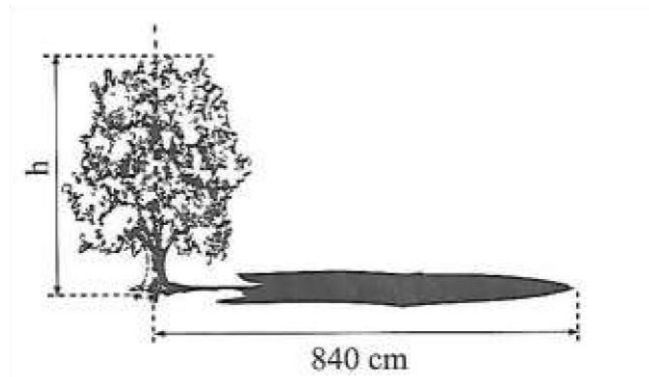
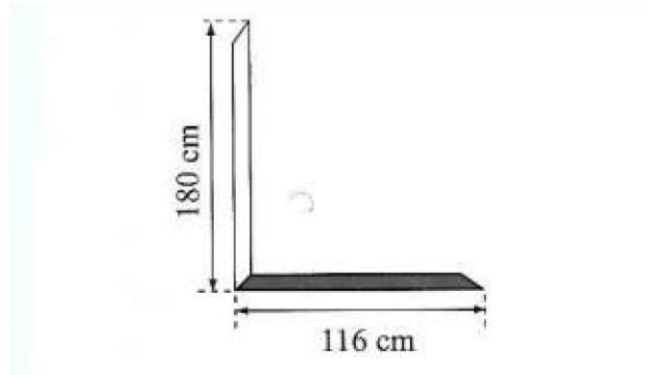

6. Estimate the area of the irregular surface shown in the figure below. (4mks)

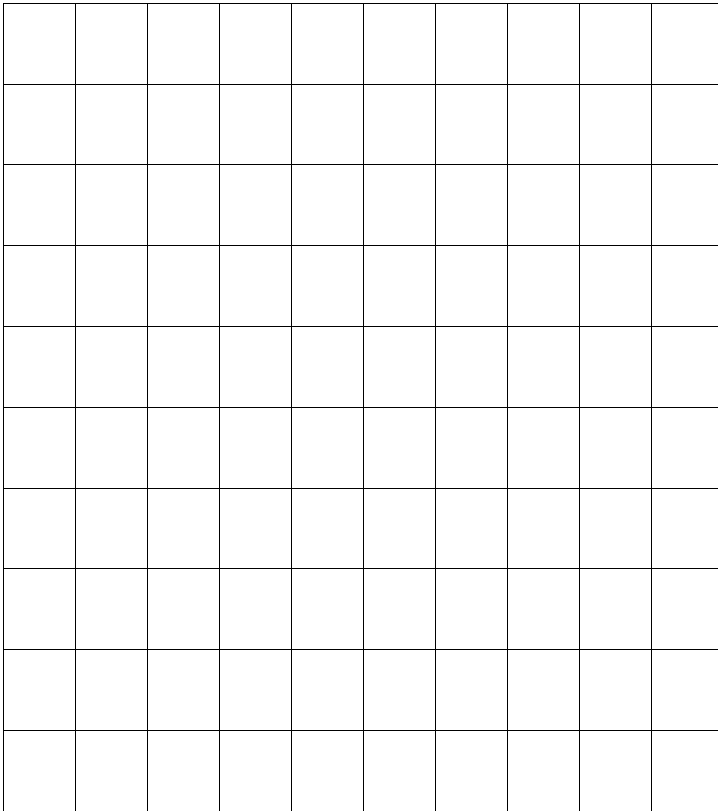

7. The density of a material is 22.5gcm^{-3} . Express this in SI units. (3mks)

8. Give 3 effects of a force. (6mks)

9. It is observed that the pollen grains are in constant motion. Explain the observation. (4mks)

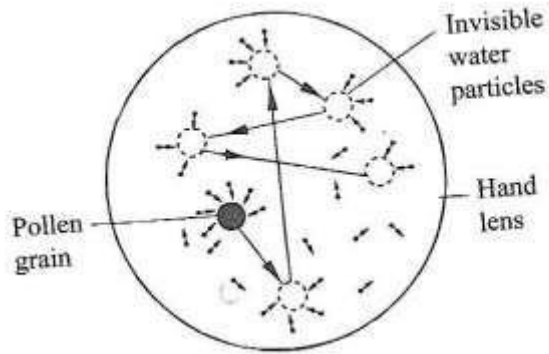

10. In a hydraulic press, a force of 200N is applied to master piston of area 25cm^2 . If the press is designed to produce a force of 5000N, determine;

(a) The area of the slave piston. (4mks)

(b) The radius of the slave piston. (4mks)

11. Explain why the walls and ceiling boards painted white. (3mks)

12. Explain the greenhouse effect and how it affects the earth. (4mks)

13. The ventilations for a room are put near the roof and not near the floor. Explain (4mks)

14.Explain how temperature affects Brownian motion.

15.Pressure is affected by many factors,study the diagram below and give reasons for such effects.
(4mks)

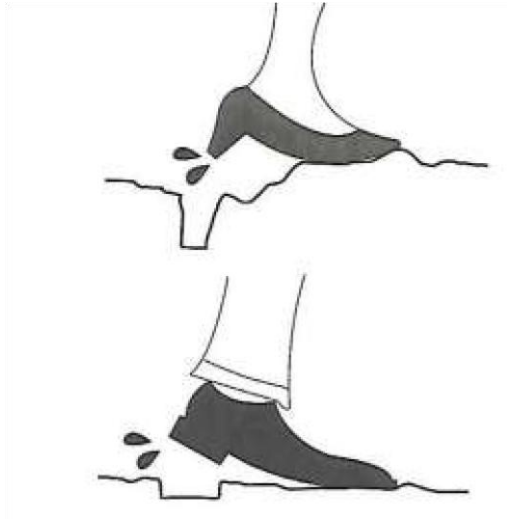

16.The ball shown below is bigger than the ring, explain an experiment to enable the ball pass through the ring.
(5 mks)

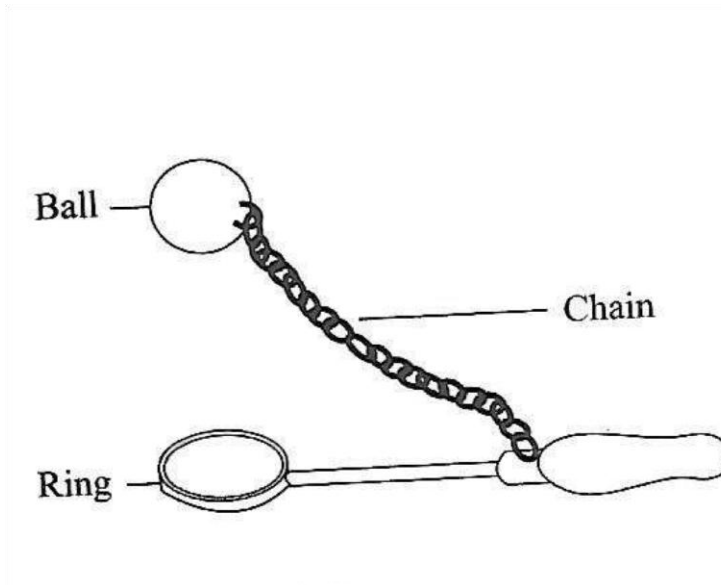

walimuepublishers@gmail.com

17. A brick 20cm long, 10cm wide and 5cm thick has a mass of 500g. Determine the (Take $g=10\text{Nkg}^{-1}$)

(a) greatest pressure that can be exerted by the brick on a flat surface. (3mks)

(b) Least pressure that can be exerted by the brick on a flat surface. (2mks)

FOR MARKING SCHEMES

CALL 0705525657

walimuepublishers@gmail.com